

**Klemmhalter mit IK-UN**

Tool holder with IK-UN

Steli con bloccaggio a vite sul IK-UN

Verfügbar in unterschiedlichen Formen

Available in different executions  
Disponibile in varie versioni

Passend für positive und negative Aussenhalter

Suitable for positive and negative tool holder  
Adatti per portautensili positivi e negativi

Längeneinstellung über definierten Bereich

The tool holder can be extended within the defined scale  
Regolazione della lunghezza attraverso marcatura sul portautensile

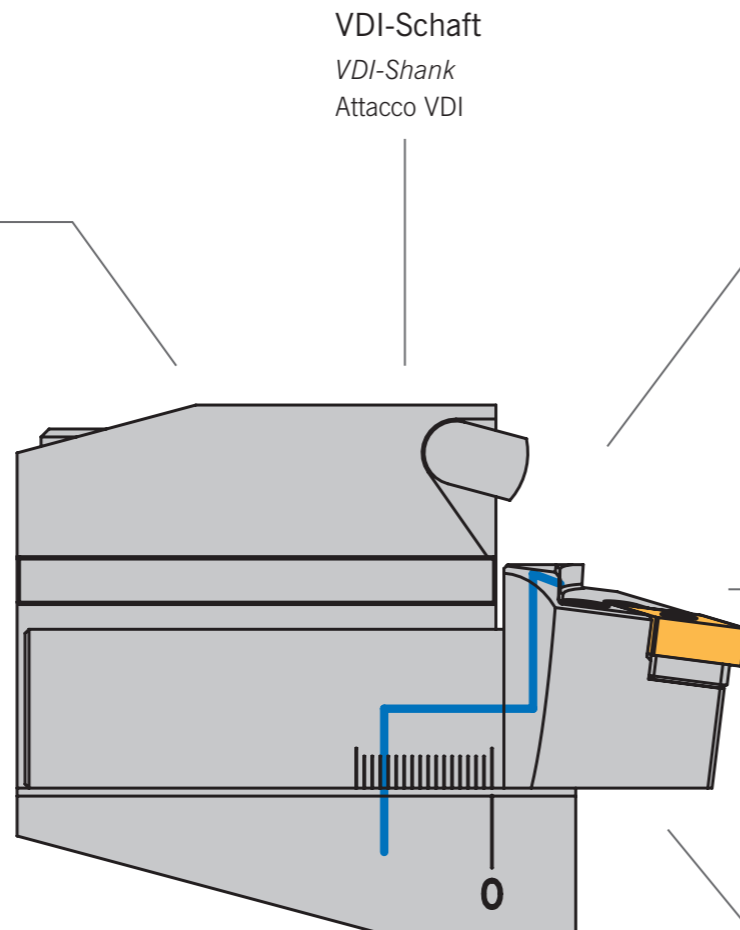

VDI-Schaft  
VDI-Shank  
Attacco VDI

Zusätzliche Kühlung über Kühlmitteldüse

Coolant jet for additional cooling  
Refrigerante addizionale attraverso il ugello

Zielgerichtete Kühlung mittels 3 Düsen auf die Schneide

Three jets for precise cooling  
Refrigerante in modo mirata direttamente sul tagliente con tre ugelli

Große Auswahl an Wendeschneidplatten für alle Materialien

Big variety of inserts for all to machine materials  
Grande gamma di inserti per tutti tipi di materiali

**Außenbearbeitung – Übersicht**

External Machining – Overview

Tornitura esterna – Gamma utensili



**Kniehebelklemmung negativ / Lever Lock Clamping negative / Bloccaggio a leva negativi**

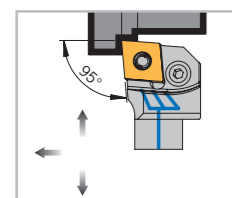

PCLN  
R/L

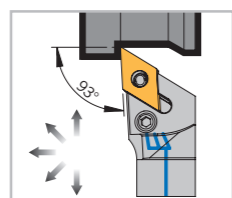

PDJN  
R/L

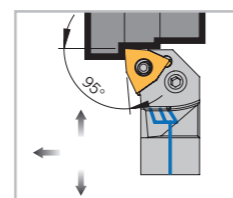

PWLN  
R/L

**Schraubenklemmung positiv / Screw Clamping positive / Bloccaggio a vite positivi**

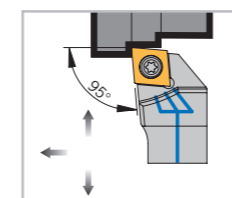

SCLC  
R/L

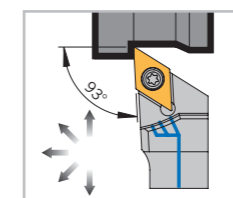

SDJC  
R/L

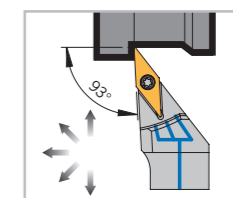

SVJC  
R/L